

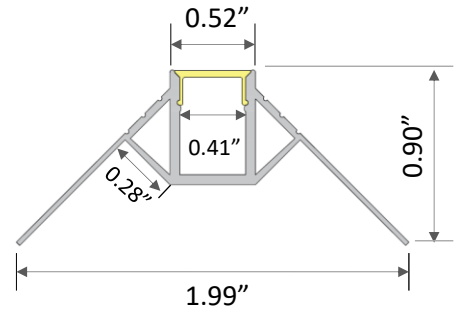

Satin Lens

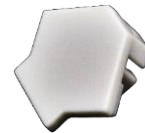

LB03OUT-EC
End Cap



Installation:

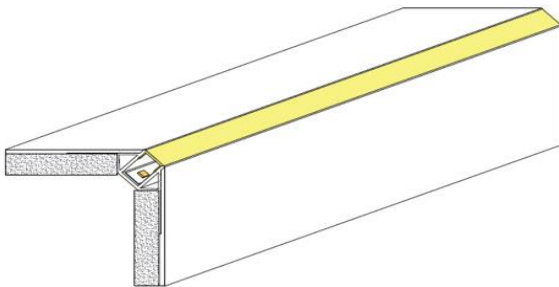

Recess with Mud-in

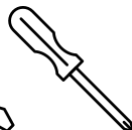

Note: each extrusion comes with 2 sets of lenses

- **Set 1: Lens A:** Prevents debris from entering extrusion; install first, then to be discarded after painting
- **Set 2: Lens B:** Clean lenses for finished installation

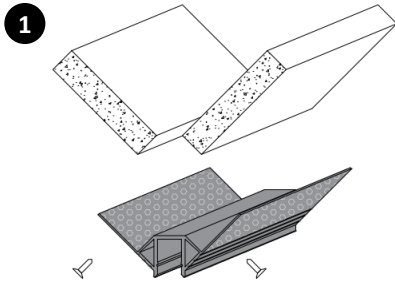

1 Make an outer corner slot .52" wide and secure extrusion to mounting surface through flanges.

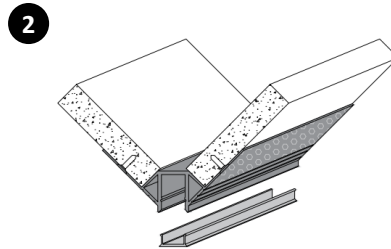

2 Secure lens A onto extrusion.

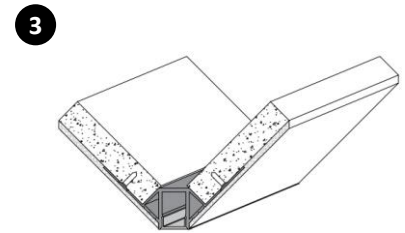

3 Mud over the flanges, then finish and paint.

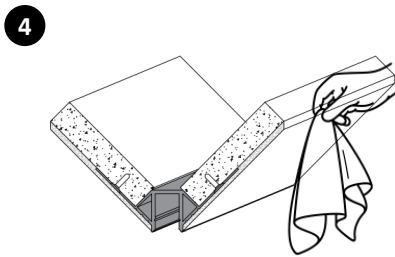

4 Remove lens A and discard. Use a soft cloth to clean inside of extrusion from all dust and debris.

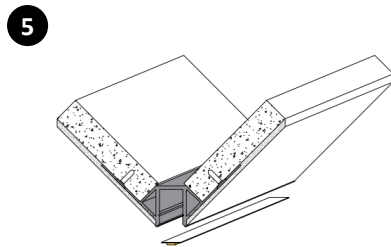

5 Adhere tape light to extrusion. Ensure there are no air pockets between extrusion and tape light.

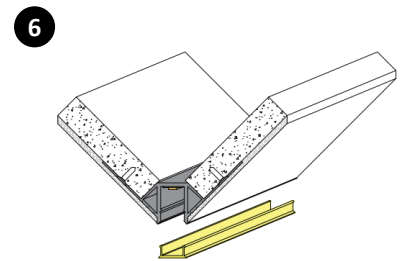

6 Snap lens B onto extrusion.

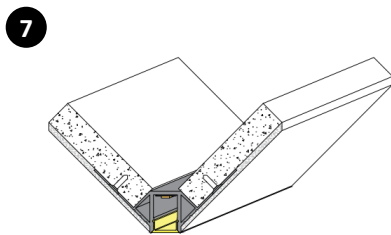

7 Enclose both ends of fixture with end caps.

This luminaire is intended for installation in accordance with local codes and the National Electric Code (NEC). Failure to adhere to these codes and instructions may result in serious injury, property damage and void the warranty. These instructions do not intend to cover all variations in installation, operation maintenance or mounting situations.



Warning

Warranty is VOID if any of the below are violated

READ AND FOLLOW ALL BELOW SAFETY INSTRUCTIONS

- Avoid any mechanical stress on the LED tape and its components
- Do not touch top of LED to prevent wire bond damage
- Do not power on the tape when rolled up in the reel
- The electrical circuit must not be damaged or interrupted during assembly
- Use only with Listed Class 2 power unit
- Follow the voltage specifications and electrical polarity to avoid irreversible damage to the LED tape
- Only qualified personnel with appropriate training and following the electrical and safety standards should carry out the installation
- The LED components are sensitive to electrostatic discharge and may be installed in the location or site only if appropriate EOS/ESD protection measures have been taken
- Do not look directly into the LEDs to prevent harm to the eyes
- Exposure of IP00 tape to moisture or very humid environments must be avoided. Any LED tape malfunction due to corrosion damage is not subject to product warranty.
- LED strip can be cut only at the marked locations or between 2 solder points. Do not touch electrical components.
- The minimum bending radius is 1 ¼ ". Bend only in areas with no electronic components.
- The maximum light output and lifespan of the LED products depend on effective thermal design. If the maximum allowed temperature is exceeded, the life of the LED tape will be reduced by great margin or eventually destroyed.
- Appropriate heat dissipation management is required by the installation. Always apply the LED tape to a metallic heat sink and ensure the maximum temperature on the tape surface does not exceed 150°F.



Caution

Warranty is VOID if any of the below are violated

