

The AC02's high-quality anodized aluminum construction and rounded lens afford a gentle aesthetic and broad light distribution, casting 180° of illumination, including lateral exposure. This design not only enhances visual comfort but also ensures superior heat dissipation.

AC02



**AC02 + AC02-SL
Satin Lens**



**AC02 + AC02-CL
Clear Lens**

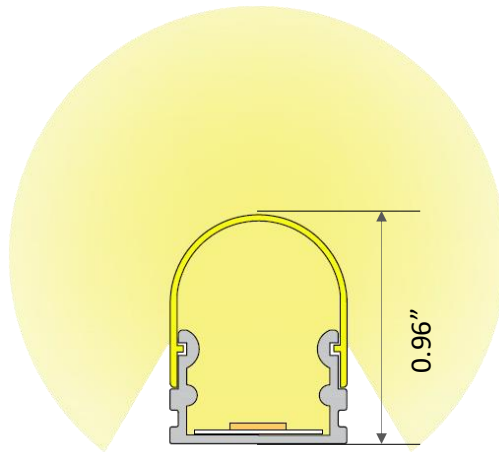
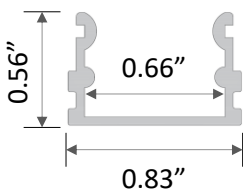

**AC02-EC
End Cap**



**AC02-MC
Mounting Clip**



Product Detail

Material:	Extruded Aluminum
Color:	Anodized Silver
Dimension (in):	L 78.74" x W 0.83" x H 0.56"
Customization:	Cut to specified length

Applications

- | | |
|---|-----------------------------------|
| <input type="checkbox"/> Hallways | <input type="checkbox"/> Cove |
| <input type="checkbox"/> Narrow/Shallow | <input type="checkbox"/> Millwork |
| <input type="checkbox"/> Furniture | <input type="checkbox"/> Handrail |
| <input type="checkbox"/> Steps/Staircases | <input type="checkbox"/> Vanity |
| <input type="checkbox"/> Under Cabinet | <input type="checkbox"/> Office |
| <input type="checkbox"/> Shelves | <input type="checkbox"/> Bathroom |
| <input type="checkbox"/> Wall | |

Compatible LED Tapelight

Product	Output (lm/ft)	LEDs/ft	Consump. (watt/ft)	Efficacy (lm/watt)	CRI	Voltage	Max Length	Min Cut
---------	----------------	---------	--------------------	--------------------	-----	---------	------------	---------

Florence (Specification Grade)

L90	~ 90	36	~ 0.73	~ 123	>90	24V	75'	1.97"
L200	~ 200	36	~ 1.46	~ 140	>90	24V	49'	1.97"
L360	~ 360	36	~ 3.12	~ 117	>90	24V	42'	1.97"
L500	~ 500	36	~ 4.39	~ 135	>90	24V	36'	1.97"
L780	~ 780	36	~ 6.72	~ 108	>90	24V	24'	1.97"
L990	~ 990	36	~ 9.36	~ 106	>90	24V	16'	1.97"
RGB-3535	~ 170	36	~ 4.4	~ 39	N/A	24V	23'	1.97"
RGB-3838	~ 280	73	~ 5.0	~ 56	N/A	24V	16'	1.00"
RGB-5050	~ 230	29	~ 7.0	~ 23	N/A	24V	13'	2.46"
RGBW	~ 330	29	~ 7.3	~ 47	N/A	24V	13'	2.46"
TW1865	~ 60-850	73	~ 5.8	~ 10-146	>90	24V	16'	1.97"
TW2740	~ 210-430	73	~ 5.8	~ 36-74	>90	24V	16'	1.97"
Dim-To-Warm	~ 168	73	~ 4.4	~ 38	>90	24V	16'	1.97"

Athens (Economy)

L240	~ 240	36	~ 2.29	~ 115	>90	24V	39'	1.97"
L460	~ 460	36	~ 4.27	~ 115	>90	24V	26'	1.97"
L680	~ 680	36	~ 6.40	~ 105	>90	24V	20'	1.97"

Compatible SOB Tapelight

Product	Output (lm/ft)	IP Rating	Consump. (watt/ft)	Efficacy (lm/watt)	CRI	Voltage	Max Length	Min Cut
---------	----------------	-----------	--------------------	--------------------	-----	---------	------------	---------

Coblence H (High CRI)

L195	~ 195	IP20	~ 2.93	~ 80	>97	24V	49'	1.97"
L220	~ 220	IP67	~ 2.93	~ 80	>97	24V	65'	1.97"
L325	~ 325	IP67	~ 4.88	~ 70	>97	24V	32'	1.16"

Coblence S (Specification Grade)







L280	~ 280	IP20	~ 2.93	~ 100	>90	24V	49'	1.97"
L335	~ 335	IP67	~ 2.93	~ 120	>90	24V	65'	1.97"
L465	~ 465	IP67	~ 4.88	~ 100	>90	24V	32'	1.16"
RGBW	RGBW	IP67	~ 4.27	~ 50	N/A	24V	16'	2.19"

Ordering Code: AC02 + Tapelight + Accessories + Lengths

AC02	- SL	- F	- L200	IP00	CT35	- EC	- MC	- 4'
------	------	-----	--------	------	------	------	------	------

Extrusion	Lens	Tapelight				End Cap	Mounting	Length		
AC02	CL – Clear Lens	F – Florence	L090	~90 lm/ft	IP00	CT27	2700K	EC – End Cap	MC – Mounting Clip	Enter run length
			L200	~200 lm/ft	IP66	CT30	3000K			
	L360		~360 lm/ft		CT35	3500K				
	L500		~500 lm/ft		CT40	4000K				
	L780		~780 lm/ft							
	L990		~990 lm/ft							
	RGB-3535 RGB			IP20	N/A					
	RGB-3838 RGB			IP54						
	RGB-5050 RGB			IP20 IP65	N/A					
	RGBW RGBW			IP00 IP54	N/A					
	TW1865 TW		IP00	1800-6500K						
	TW2740 TW		IP65	2700-4000K						
	DTW Dim-To-Warm		IP00 IP54	CT2130 2100-3000K						
		A – Athens	L240	~240 lm/ft	IP00	CT27	2700K			
			L460	~460 lm/ft	IP66	CT30	3000K			
			L680	~680 lm/ft		CT35	3500K			
					CT40	4000K				
		CH – Coblence H	L195	~195 lm/ft	IP20	CT27	2700K			
			L220	~220 lm/ft	IP67	CT30	3000K			
			L235	~235 lm/ft	IP67	CT35	3500K			
					CT40	4000K				
		CS – Coblence S	L280	~280 lm/ft	IP20	CT27	2700K			
			L335	~335 lm/ft	IP67	CT30	3000K			
			L465	~465 lm/ft	IP67	CT35	3500K			
						CT40	4000K			
			RGBW RGBW		IP67	N/A				

Power Supply Ordering Codes

DTR		+	60		+	IP67		DTR60IP67 - Dimming, 60 Watt, IP67							
MODEL		+	POWER		+	IP RATING		INPUT	OUTPUT	DIMENSION					
NTR Non-Dimming [UL Recognized]			50	50 Watt		IP00 Indoor	88-264V	24V	3.90 x 3.82 x 1.42						
			75	75 Watt					5.08 x 3.82 x 1.50						
			100	100 Watt					6.26 x 3.82 x 1.50						
			150	150 Watt					7.84 x 3.85 x 1.50						
			200	200 Watt					8.46 x 4.53 x 1.18						
			320	320 Watt					8.46 x 4.53 x 1.18						
			750	750 Watt					9.84 x 5.00 x 1.61						
			960	960 Watt					11.60 x 5.00 x 1.61						
			12	12 Watt						IP42 Indoor	90-264V	24V	3.03 x 1.57 x 1.14		
			16	16 Watt									3.03 x 1.57 x 1.14		
		25	25 Watt	3.31 x 2.24 x 1.16											
		35	35 Watt	3.31 x 2.24 x 1.16											
		20	20 Watt		IP67 Outdoor	90-264V	24V	4.65 x 1.38 x 1.02							
		35	35 Watt					5.83 x 1.57 x 1.18							
		60	60 Watt					6.40 x 1.67 x 1.26							
		100	100 Watt					7.48 x 2.05 x 1.46							
		150	150 Watt					7.52 x 2.48 x 1.48							
		240	240 Watt					9.61 x 2.68 x 1.53							
		320	320 Watt	9.92 x 3.54 x 1.72											
DTR Dimming min 10% (0-10V) [UL Recognized]			16	16 Watt		IP30 Indoor	90-305V	24V	5.83 x 1.57 x 1.26						
			25	25 Watt						IP67 Outdoor	90-305V	24V	5.83 x 1.57 x 1.26		
			40	40 Watt									6.40 x 1.70 x 1.26		
			60	60 Watt									6.40 x 1.70 x 1.26		
			90	90 Watt									6.34 x 2.40 x 1.42		
			96	96 Watt									8.66 x 2.68 x 1.53		
			120	120 Watt									8.66 x 2.68 x 1.53		
			150	150 Watt									8.97 x 2.68 x 1.58		
			185	185 Watt									8.97 x 2.68 x 1.58		
			240	240 Watt									9.88 x 2.68 x 1.58		
		320	320 Watt	9.92 x 3.54 x 1.72											
		480	480 Watt	10.32 x 4.92 x 1.72											
		600	600 Watt	11.02 X 5.67 X 1.91											
FPD Dimming min 1% (Forward Phase) [UL Recognized]			20	20 Watt		IP67 Outdoor	120V	24V	4.92 x 2.20 x 0.79						
			40	40 Watt					4.92 x 2.20 x 0.79						
			60	60 Watt					4.92 x 2.20 x 0.79						
			75	75 Watt					4.92 x 2.20 x 0.79						
			96	96 Watt					4.92 x 2.20 x 0.79						
FPD Dimming min 1% (Forward Phase) with junction box [ETL Listed]			20	20 Watt		IP14 Outdoor	120V	24V	5.60 x 2.00 x 2.14						
			40	40 Watt					5.60 x 2.00 x 2.14						
			60	60 Watt					6.62 x 2.58 x 2.33						
			96	96 Watt					6.62 x 2.58 x 2.33						
			150	150 Watt					9.80 x 3.00 x 2.74						
			200	200 Watt					9.80 x 3.00 x 2.74						
		300	300 Watt	10.07 x 4.20 x 3.50											

CUSTOMIZATION	TL48	DC99	LN99	EX99	M99	C99	F48	F48C	IP68
Cutting tapelight to specified length + solder 4ft leadwire	✓						✓	✓	
Daisy Chain: Cut tapelight to specified length + 2", 6", or 12" jumper cable daisy chain between 2 run lengths		✓							
Installing tapelight onto extrusion							✓	✓	
Cutting diffuser to specified length			✓				✓	✓	
Cutting extrusion to specified length				✓			✓	✓	
Miter corner extrusion and diffuser					✓				
Filling extrusion with polyurethane (2 ft submersible)									✓
Customize extrusion to specified color						✓		✓	
Final function and quality inspection	✓	✓	✓	✓	✓	✓	✓	✓	✓