

The LB03OUT introduces an innovative extrusion design that elegantly transforms outer drywall corners into refined lines of light. Available in white, tunable white, static colors, or RGB, it enables customization to suit varied design preferences, adding a stunning visual impact to any space.

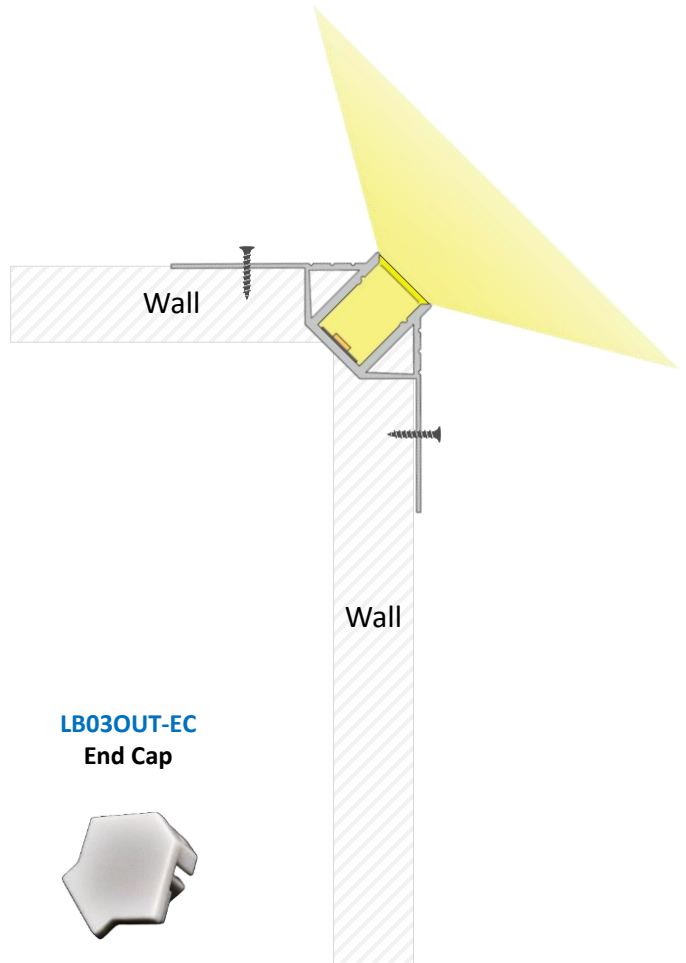

LB03OUT + LB03-SL
Satined Lens

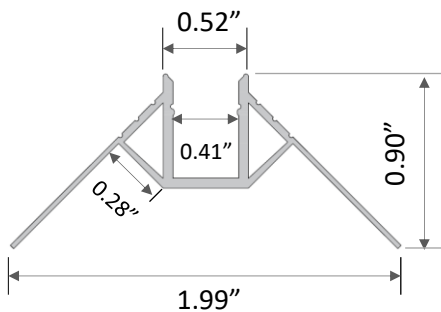

Product Detail

Material:	Extruded Aluminum
Color:	Anodized Silver
Dimension (in):	L 78.74" x W 1.99" x H 0.90"
Customization:	Cut to specified length

Applications

- Drywall Outer Corner

Compatible LED Tapelight

Product	Output (lm/ft)	LEDs/ft	Consump. (watt/ft)	Efficacy (lm/watt)	CRI	Voltage	Max Length	Min Cut
---------	----------------	---------	--------------------	--------------------	-----	---------	------------	---------

Florence (Specification Grade)

L90	~ 90	36	~ 0.73	~ 123	>90	24V	75'	1.97"
L200	~ 200	36	~ 1.46	~ 140	>90	24V	49'	1.97"
L360	~ 360	36	~ 3.12	~ 117	>90	24V	42'	1.97"
L500	~ 500	36	~ 4.39	~ 135	>90	24V	36'	1.97"
RGB-3535	~ 170	36	~ 4.4	~ 39	N/A	24V	23'	1.97"
RGB-5050	~ 230	29	~ 7.0	~ 23	N/A	24V	13'	2.46"
TW1865	~ 60-850	73	~ 5.8	~ 10-146	>90	24V	16'	1.97"
TW2740	~ 210-430	73	~ 5.8	~ 36-74	>90	24V	16'	1.97"
Dim-To-Warm	~ 168	73	~ 4.4	~ 38	>90	24V	16'	1.97"

Athens (Economy)

L240	~ 240	36	~ 2.29	~ 115	>90	24V	39'	1.97"
L460	~ 460	36	~ 4.27	~ 115	>90	24V	26'	1.97"

Compatible SOB Tapelight

Product	Output (lm/ft)	IP Rating	Consump. (watt/ft)	Efficacy (lm/watt)	CRI	Voltage	Max Length	Min Cut
---------	----------------	-----------	--------------------	--------------------	-----	---------	------------	---------

Coblence H (High CRI)

L195	~ 195	IP20	~ 2.93	~ 80	>97	24V	49'	1.97"
L220	~ 220	IP67	~ 2.93	~ 80	>97	24V	65'	1.97"
L325	~ 325	IP67	~ 4.88	~ 70	>97	24V	32'	1.16"

Coblence S (Specification Grade)







L280	~ 280	IP20	~ 2.93	~ 100	>90	24V	49'	1.97"
L335	~ 335	IP67	~ 2.93	~ 120	>90	24V	65'	1.97"
L465	~ 465	IP67	~ 4.88	~ 100	>90	24V	32'	1.16"
RGBW	RGBW	IP67	~ 4.27	~ 50	N/A	24V	16'	2.19"

Ordering Code: LB03OUT + Tapelight + Accessories + Lengths

LB03OUT	- SL	- F	- L200	IP00	CT35	- EC	- 4'
---------	------	-----	--------	------	------	------	------

Extrusion	Lens	Tapelight				End Cap	Length	
LB03OUT	SL – Satined Lens	F – Florence	L090	~90 lm/ft	IP00	CT27	2700K	EC – End Cap Enter run length
			L200	~200 lm/ft	IP66	CT30	3000K	
			L360	~360 lm/ft		CT35	3500K	
			L500	~500 lm/ft		CT40	4000K	
			RGB-3535	RGB	IP20 IP54	N/A		
		RGB-5050	RGB	IP20 IP65	N/A			
		TW1865	TW	IP00	1800-6500K			
		TW2740	TW	IP65	2700-4000K			
		DTW	Dim-To-Warm	IP00 IP54	CT2130 2100-3000K			
		A – Athens	L240	~240 lm/ft	IP00	CT27	2700K	
			L460	~460 lm/ft	IP66	CT30 CT35 CT40	3000K 3500K 4000K	
		CH – Coblence H	L195	~195 lm/ft	IP20	CT27	2700K	
			L220	~220 lm/ft	IP67	CT30	3000K	
			L235	~235 lm/ft	IP67	CT35 CT40	3500K 4000K	
		CS – Coblence S	L280	~280 lm/ft	IP20	CT27	2700K	
L335	~335 lm/ft		IP67	CT30	3000K			
L465	~465 lm/ft		IP67	CT35 CT40	3500K 4000K			
RGBW	RGBW		IP67	N/A				

Power Supply Ordering Codes

DTR		+	60		+	IP67		DTR60IP67 - Dimming, 60 Watt, IP67					
MODEL		+	POWER		+	IP RATING		INPUT	OUTPUT	DIMENSION			
NTR Non-Dimming [UL Recognized]			50	50 Watt		IP00 Indoor	88-264V	24V	3.90 x 3.82 x 1.42				
		75	75 Watt	5.08 x 3.82 x 1.50									
		100	100 Watt	6.26 x 3.82 x 1.50									
		150	150 Watt	7.84 x 3.85 x 1.50									
		200	200 Watt	8.46 x 4.53 x 1.18									
		320	320 Watt	8.46 x 4.53 x 1.18									
		750	750 Watt	9.84 x 5.00 x 1.61									
		960	960 Watt	11.60 x 5.00 x 1.61									
		12	12 Watt						IP42 Indoor	90-264V	24V	3.03 x 1.57 x 1.14	
		16	16 Watt									3.03 x 1.57 x 1.14	
	25	25 Watt	3.31 x 2.24 x 1.16										
	35	35 Watt	3.31 x 2.24 x 1.16										
	20	20 Watt		IP67 Outdoor	90-264V	24V	4.65 x 1.38 x 1.02						
	35	35 Watt					5.83 x 1.57 x 1.18						
	60	60 Watt					6.40 x 1.67 x 1.26						
	100	100 Watt					7.48 x 2.05 x 1.46						
	150	150 Watt					7.52 x 2.48 x 1.48						
	240	240 Watt					9.61 x 2.68 x 1.53						
	320	320 Watt	9.92 x 3.54 x 1.72										
DTR Dimming min 10% (0-10V) [UL Recognized]		16	16 Watt		IP30 Indoor	90-305V	24V	5.83 x 1.57 x 1.26					
		25	25 Watt						IP67 Outdoor	90-305V	24V	5.83 x 1.57 x 1.26	
		40	40 Watt									6.40 x 1.70 x 1.26	
		60	60 Watt									6.40 x 1.70 x 1.26	
		90	90 Watt									6.34 x 2.40 x 1.42	
		96	96 Watt									8.66 x 2.68 x 1.53	
		120	120 Watt									8.66 x 2.68 x 1.53	
		150	150 Watt									8.97 x 2.68 x 1.58	
		185	185 Watt									8.97 x 2.68 x 1.58	
		240	240 Watt									9.88 x 2.68 x 1.58	
	320	320 Watt	9.92 x 3.54 x 1.72										
	480	480 Watt	10.32 x 4.92 x 1.72										
	600	600 Watt	11.02 X 5.67 X 1.91										
FPD Dimming min 1% (Forward Phase) [UL Recognized]		20	20 Watt		IP67 Outdoor	120V	24V	4.92 x 2.20 x 0.79					
		40	40 Watt					4.92 x 2.20 x 0.79					
		60	60 Watt					4.92 x 2.20 x 0.79					
		75	75 Watt					4.92 x 2.20 x 0.79					
		96	96 Watt					4.92 x 2.20 x 0.79					
FPD Dimming min 1% (Forward Phase) with junction box [ETL Listed]		20	20 Watt		IP14 Outdoor	120V	24V	5.60 x 2.00 x 2.14					
		40	40 Watt					5.60 x 2.00 x 2.14					
		60	60 Watt					6.62 x 2.58 x 2.33					
		96	96 Watt					6.62 x 2.58 x 2.33					
		150	150 Watt					9.80 x 3.00 x 2.74					
		200	200 Watt					9.80 x 3.00 x 2.74					
	300	300 Watt	10.07 x 4.20 x 3.50										

CUSTOMIZATION	TL48	DC99	LN99	EX99	M99	C99	F48	F48C	IP68
Cutting tapelight to specified length + solder 4ft leadwire	✓						✓	✓	
Daisy Chain: Cut tapelight to specified length + 2", 6", or 12" jumper cable daisy chain between 2 run lengths		✓							
Installing tapelight onto extrusion							✓	✓	
Cutting diffuser to specified length			✓				✓	✓	
Cutting extrusion to specified length				✓			✓	✓	
Miter corner extrusion and diffuser					✓				
Filling extrusion with polyurethane (2 ft submersible)									✓
Customize extrusion to specified color						✓		✓	
Final function and quality inspection	✓	✓	✓	✓	✓	✓	✓	✓	✓