

PH04-B | Recessed (Walk-Over PVC)

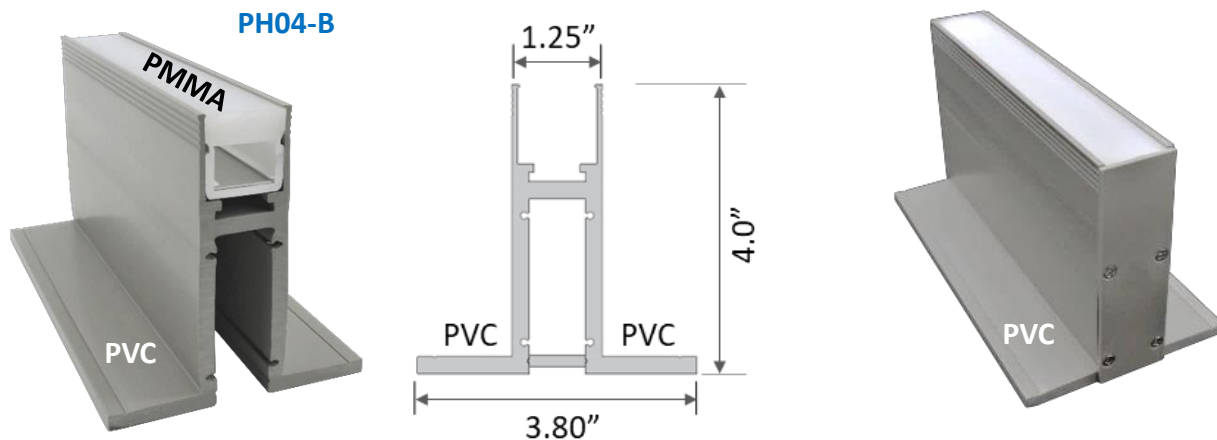

The PH04 is a recessed walk-over fixture, featuring a tough outer layer of reinforced PVC and a durable one-piece PMMA extrusion. PVC is **corrosion-resistant** in concrete installations, making maintenance easier compared to traditional ingrade fixtures. It's capable of withstanding up to 10kN and holds an IP67 rating. With a 4" height, it aligns with the common concrete pour height. The PH04 produces even light lines and can be used individually or in combination with other fixtures, ensuring shadow-free, continuous lighting both indoors and outdoors.



PH04-EC
End Cap



PH99-C
Cover



PH99-EC
End Cap

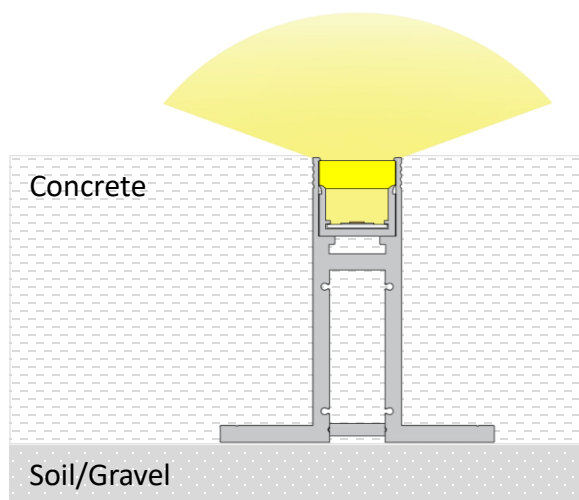

Product Detail

Material:	PVC & PMMA
Color:	Dark Gray
Dimension (in):	L 78.74" x W 3.80" x H 4.0"
Customization:	Cut to specified length

Applications

- Recessed Flangeless
- Transition Wall/Ceiling
- Hallways
- Facades
- Step Light
- Staircases
- Outdoor Uplight

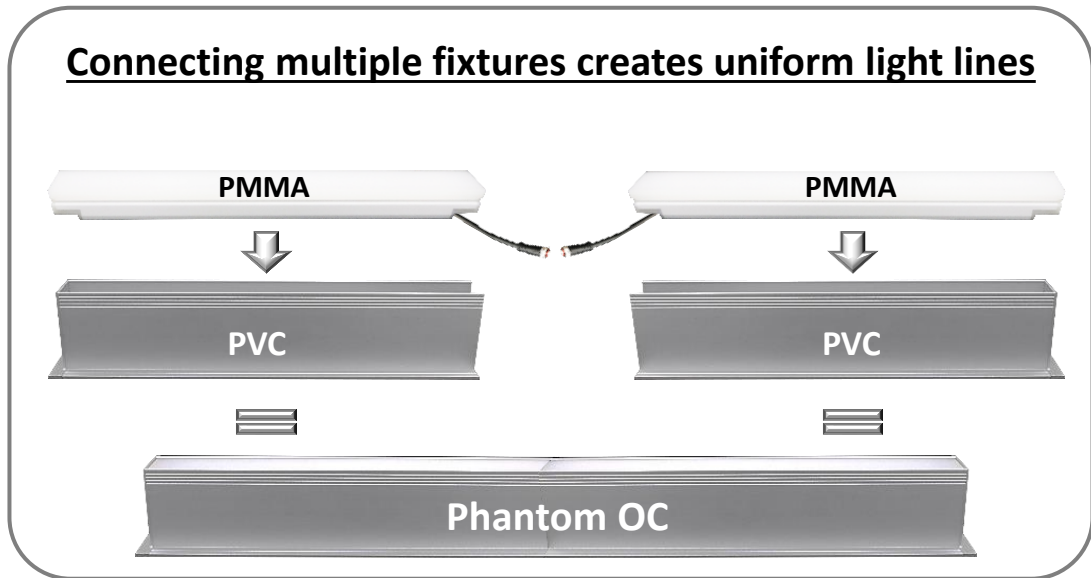

Compatible LED Taplight

Product	Output (lm/ft)	LEDs/ft	Consump. (watt/ft)	Efficacy (lm/watt)	CRI	Voltage	Max Length	Min Cut
---------	----------------	---------	--------------------	--------------------	-----	---------	------------	---------

Florence (Specification Grade)

L90	~ 90	36	~ 0.73	~ 123	>90	24V	75'	1.97"
L200	~ 200	36	~ 1.46	~ 140	>90	24V	49'	1.97"
L360	~ 360	36	~ 3.12	~ 117	>90	24V	42'	1.97"
L500	~ 500	36	~ 4.39	~ 135	>90	24V	36'	1.97"
L780	~ 780	36	~ 6.72	~ 108	>90	24V	24'	1.97"
RGB-3535	~ 170	36	~ 4.4	~ 39	N/A	24V	23'	1.97"
RGB-3838	~ 280	73	~ 5.0	~ 56	N/A	24V	16'	1.00"
RGB-5050	~ 230	29	~ 7.0	~ 23	N/A	24V	13'	2.46"
RGBW	~ 330	29	~ 7.3	~ 47	N/A	24V	13'	2.46"
TW1865	~ 60-850	73	~ 5.8	~ 10-146	>90	24V	16'	1.97"
TW2740	~ 210-430	73	~ 5.8	~ 36-74	>90	24V	16'	1.97"
Dim-To-Warm	~ 168	73	~ 4.4	~ 38	>90	24V	16'	1.97"







Athens (Economy)

L240	~ 240	36	~ 2.29	~ 115	>90	24V	39'	1.97"
L460	~ 460	36	~ 4.27	~ 115	>90	24V	26'	1.97"
L680	~ 680	36	~ 6.40	~ 105	>90	24V	20'	1.97"

Ordering Code: PH04-B + Tapelight + Accessories + Lengths

PH04-B	- C	- F	- L200	IP00	CT35	- EC	- 4'	
Extrusion	Cover	Tapelight				End Cap	Length	
PH04-B	C – Cover	F – Florence	L090	~90 lm/ft	IP00	CT27	2700K	EC – End Cap Enter run length
			L200	~200 lm/ft	IP66	CT30	3000K	
			L360	~360 lm/ft		CT35	3500K	
			L500	~500 lm/ft		CT40	4000K	
			L780	~780 lm/ft				
				RGB-3535	RGB	IP20	N/A	
				RGB-3838	RGB	IP54		
				RGB-5050	RGB	IP20 IP65	N/A	
				RGBW	RGBW	IP00 IP54	N/A	
				TW1865	TW	IP00	1800-6500K	
				TW2740	TW	IP65	2700-4000K	
		DTW	Dim-To-Warm	IP00 IP54	CT2130 2100-3000K			
		A – Athens	L240	~240 lm/ft	IP00	CT27	2700K	
			L460	~460 lm/ft	IP66	CT30	3000K	
			L680	~680 lm/ft		CT35	3500K	
						CT40	4000K	

Power Supply Ordering Codes

DTR		+	60		+	IP67		DTR60IP67 - Dimming, 60 Watt, IP67							
MODEL		+	POWER		+	IP RATING		INPUT	OUTPUT	DIMENSION					
NTR Non-Dimming [UL Recognized]			50	50 Watt		IP00	Indoor	88-264V	24V	3.90 x 3.82 x 1.42					
		75	75 Watt	5.08 x 3.82 x 1.50											
		100	100 Watt	6.26 x 3.82 x 1.50											
		150	150 Watt	7.84 x 3.85 x 1.50											
		200	200 Watt	8.46 x 4.53 x 1.18											
		320	320 Watt	8.46 x 4.53 x 1.18											
		750	750 Watt	9.84 x 5.00 x 1.61											
		960	960 Watt	11.60 x 5.00 x 1.61											
		12	12 Watt				IP42			Indoor	90-264V	24V	3.03 x 1.57 x 1.14		
		16	16 Watt										3.03 x 1.57 x 1.14		
	25	25 Watt	3.31 x 2.24 x 1.16												
	35	35 Watt	3.31 x 2.24 x 1.16												
	20	20 Watt		IP67	Outdoor	90-264V	24V	4.65 x 1.38 x 1.02							
	35	35 Watt						5.83 x 1.57 x 1.18							
	60	60 Watt						6.40 x 1.67 x 1.26							
	100	100 Watt						7.48 x 2.05 x 1.46							
	150	150 Watt						7.52 x 2.48 x 1.48							
	240	240 Watt						9.61 x 2.68 x 1.53							
	320	320 Watt	9.92 x 3.54 x 1.72												
DTR Dimming min 10% (0-10V) [UL Recognized]		16	16 Watt		IP30	Indoor	90-305V	24V	5.83 x 1.57 x 1.26						
		25	25 Watt							IP67	Outdoor	90-305V	24V	5.83 x 1.57 x 1.26	
		40	40 Watt											6.40 x 1.70 x 1.26	
		60	60 Watt											6.40 x 1.70 x 1.26	
		90	90 Watt											6.34 x 2.40 x 1.42	
		96	96 Watt											8.66 x 2.68 x 1.53	
		120	120 Watt											8.66 x 2.68 x 1.53	
		150	150 Watt											8.97 x 2.68 x 1.58	
		185	185 Watt											8.97 x 2.68 x 1.58	
		240	240 Watt											9.88 x 2.68 x 1.58	
	320	320 Watt	9.92 x 3.54 x 1.72												
	480	480 Watt	10.32 x 4.92 x 1.72												
	600	600 Watt	11.02 X 5.67 X 1.91												
FPD Dimming min 1% (Forward Phase) [UL Recognized]		20	20 Watt		IP67	Outdoor	120V	24V	4.92 x 2.20 x 0.79						
		40	40 Watt						4.92 x 2.20 x 0.79						
		60	60 Watt						4.92 x 2.20 x 0.79						
		75	75 Watt						4.92 x 2.20 x 0.79						
		96	96 Watt						4.92 x 2.20 x 0.79						
FPD Dimming min 1% (Forward Phase) with junction box [ETL Listed]		20	20 Watt		IP14	Outdoor	120V	24V	5.60 x 2.00 x 2.14						
		40	40 Watt						5.60 x 2.00 x 2.14						
		60	60 Watt						6.62 x 2.58 x 2.33						
		96	96 Watt						6.62 x 2.58 x 2.33						
		150	150 Watt						9.80 x 3.00 x 2.74						
		200	200 Watt						9.80 x 3.00 x 2.74						
	300	300 Watt	10.07 x 4.20 x 3.50												

CUSTOMIZATION	TL48	DC99	LN99	EX99	M99	C99	F48	F48C	IP68
Cutting tapelight to specified length + solder 4ft leadwire	✓						✓	✓	
Daisy Chain: Cut tapelight to specified length + 2", 6", or 12" jumper cable daisy chain between 2 run lengths		✓							
Installing tapelight onto extrusion							✓	✓	
Cutting diffuser to specified length			✓				✓	✓	
Cutting extrusion to specified length				✓			✓	✓	
Miter corner extrusion and diffuser					✓				
Filling extrusion with polyurethane (2 ft submersible)									✓
Customize extrusion to specified color						✓		✓	
Final function and quality inspection	✓	✓	✓	✓	✓	✓	✓	✓	✓