

The XT02 is a popular, compact surface-mounted extrusion capable of accommodating all lumen output tapes in the Beulux range. Constructed from anodized aluminum, it not only provides excellent heat dissipation but also ensures versatility and durability for various lighting projects.

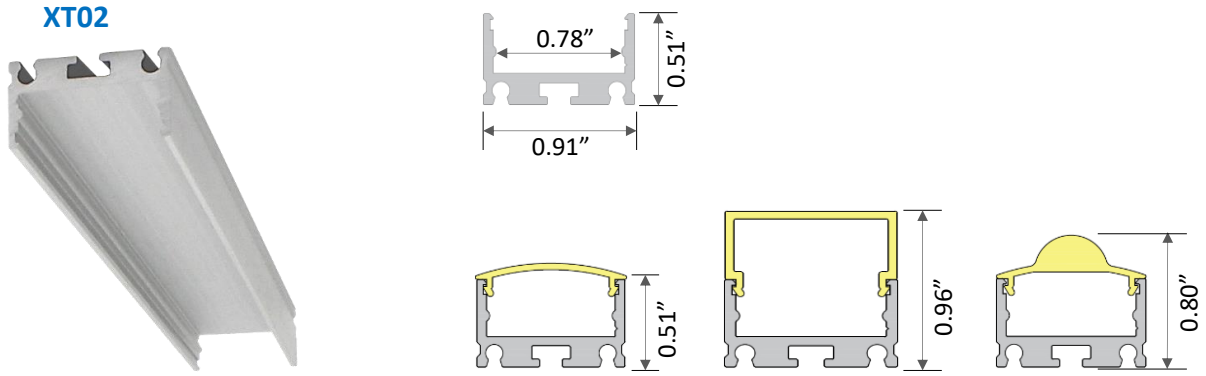

Seamless Lens available up to 65.5 ft

XT02 + XT99-SLS
Seamless Satined Lens



XT02 + XT99-CLS
Seamless Clear Lens



XT02 + XT99-DL
Drop Lens



XT02 + XT99-CL30
30° Lens



XT02-EC
End Cap



XT02-ECD
End Cap (DL)



BL15-MCL
Mounting Clip



BL15-AA
Adj. Angle



BL15-AA90
90° Adj. Angle



BL15-CN180
Connector



BL15-CN90
90° Connector



Product Detail

| | |
|----------------|------------------------------|
| Material: | Extruded Aluminum |
| Color: | Anodized Silver |
| Size in inch: | L 78.74" x W 0.91" x H 0.51" |
| Customization: | Cut to specified length |

Applications

- | | |
|--|-----------------------------------|
| <input type="checkbox"/> Surface Mount | <input type="checkbox"/> Cove |
| <input type="checkbox"/> Transition Wall/Ceiling | <input type="checkbox"/> Millwork |
| <input type="checkbox"/> Curved Wall | <input type="checkbox"/> Handrail |
| <input type="checkbox"/> Hallways | <input type="checkbox"/> Vanity |
| <input type="checkbox"/> Pendant | <input type="checkbox"/> Office |

Surface Mount

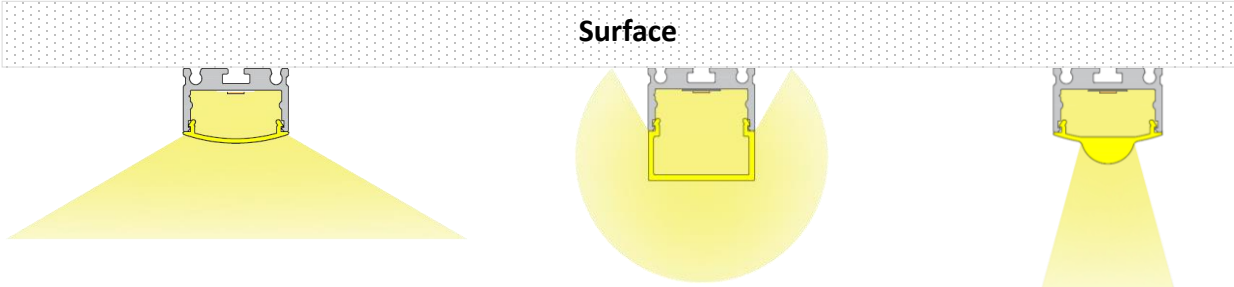

Pendant

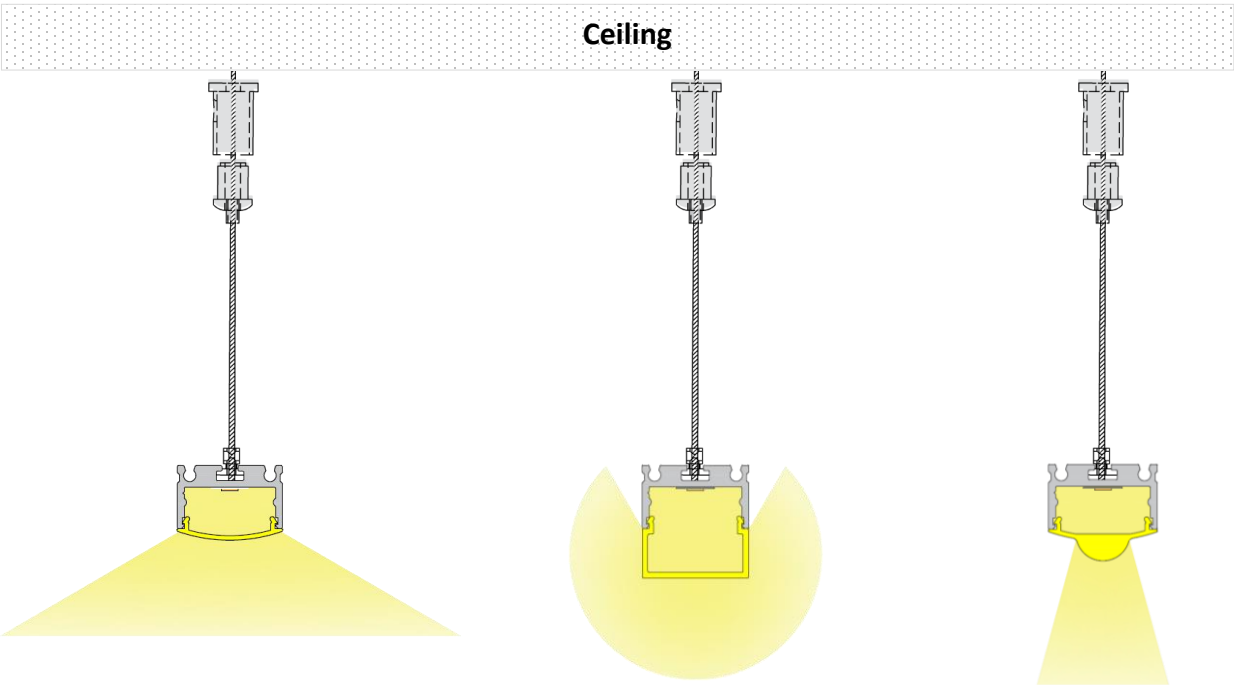

Compatible LED Tapelight

| Product | Output (lm/ft) | LEDs/ft | Consump. (watt/ft) | Efficacy (lm/watt) | CRI | Voltage | Max Length | Min Cut |
|---------|----------------|---------|--------------------|--------------------|-----|---------|------------|---------|
|---------|----------------|---------|--------------------|--------------------|-----|---------|------------|---------|

Florence (Specification Grade)

| | | | | | | | | |
|-------------|-----------|----|--------|----------|-----|-----|-----|-------|
| L90 | ~ 90 | 36 | ~ 0.73 | ~ 123 | >90 | 24V | 75' | 1.97" |
| L200 | ~ 200 | 36 | ~ 1.46 | ~ 140 | >90 | 24V | 49' | 1.97" |
| L360 | ~ 360 | 36 | ~ 3.12 | ~ 117 | >90 | 24V | 42' | 1.97" |
| L500 | ~ 500 | 36 | ~ 4.39 | ~ 135 | >90 | 24V | 36' | 1.97" |
| L780 | ~ 780 | 36 | ~ 6.72 | ~ 108 | >90 | 24V | 24' | 1.97" |
| L990 | ~ 990 | 36 | ~ 9.36 | ~ 106 | >90 | 24V | 16' | 1.97" |
| RGB-3535 | ~ 170 | 36 | ~ 4.4 | ~ 39 | N/A | 24V | 23' | 1.97" |
| RGB-3838 | ~ 280 | 73 | ~ 5.0 | ~ 56 | N/A | 24V | 16' | 1.00" |
| RGB-5050 | ~ 230 | 29 | ~ 7.0 | ~ 23 | N/A | 24V | 13' | 2.46" |
| RGBW | ~ 330 | 29 | ~ 7.3 | ~ 47 | N/A | 24V | 13' | 2.46" |
| TW1865 | ~ 60-850 | 73 | ~ 5.8 | ~ 10-146 | >90 | 24V | 16' | 1.97" |
| TW2740 | ~ 210-430 | 73 | ~ 5.8 | ~ 36-74 | >90 | 24V | 16' | 1.97" |
| Dim-To-Warm | ~ 168 | 73 | ~ 4.4 | ~ 38 | >90 | 24V | 16' | 1.97" |

Athens (Economy)

| | | | | | | | | |
|------|-------|----|--------|-------|-----|-----|-----|-------|
| L240 | ~ 240 | 36 | ~ 2.29 | ~ 115 | >90 | 24V | 39' | 1.97" |
| L460 | ~ 460 | 36 | ~ 4.27 | ~ 115 | >90 | 24V | 26' | 1.97" |
| L680 | ~ 680 | 36 | ~ 6.40 | ~ 105 | >90 | 24V | 20' | 1.97" |

Madrid (Line Voltage)

| | | | | | | | | |
|------|-------|----|-------|------|-----|------|------|------|
| L300 | ~ 300 | 18 | ~ 4.0 | ~ 75 | >90 | 120V | 164' | 4.0" |
| L500 | ~ 500 | 28 | ~ 6.0 | ~ 85 | >90 | 120V | 100' | 3.0" |
| RGBW | n/a | 60 | ~ 3.0 | n/a | >90 | 120V | 164' | 1.0' |

Compatible SOB Tapelight

| Product | Output (lm/ft) | IP Rating | Consump. (watt/ft) | Efficacy (lm/watt) | CRI | Voltage | Max Length | Min Cut |
|---------|----------------|-----------|--------------------|--------------------|-----|---------|------------|---------|
|---------|----------------|-----------|--------------------|--------------------|-----|---------|------------|---------|

Coblence H (High CRI)

| | | | | | | | | |
|------|-------|------|--------|------|-----|-----|-----|-------|
| L195 | ~ 195 | IP20 | ~ 2.93 | ~ 80 | >97 | 24V | 49' | 1.97" |
| L220 | ~ 220 | IP67 | ~ 2.93 | ~ 80 | >97 | 24V | 65' | 1.97" |
| L325 | ~ 325 | IP67 | ~ 4.88 | ~ 70 | >97 | 24V | 32' | 1.16" |

Coblence S (Specification Grade)

| | | | | | | | | |
|------|-------|------|--------|-------|-----|-----|-----|-------|
| L280 | ~ 280 | IP20 | ~ 2.93 | ~ 100 | >90 | 24V | 49' | 1.97" |
| L335 | ~ 335 | IP67 | ~ 2.93 | ~ 120 | >90 | 24V | 65' | 1.97" |
| L465 | ~ 465 | IP67 | ~ 4.88 | ~ 100 | >90 | 24V | 32' | 1.16" |
| RGBW | RGBW | IP67 | ~ 4.27 | ~ 50 | N/A | 24V | 16' | 2.19" |

Note: Lens is not required for XT02 + Coblence IP67-RGBW







Ordering Code: XT02 + Tapelight + Accessories + Lengths

| | | | | | | | | |
|------|------|-----|--------|------|-----|------|------|------|
| XT02 | - SL | - M | - RGBW | IP65 | N/A | - EC | - MC | - 4' |
|------|------|-----|--------|------|-----|------|------|------|

| Extrusion | Lens | Tapelight | | | | End Cap | Mounting | Length | | | |
|------------------|-----------------------|--------------|------------|-------------|------|------------|------------|--------------|-----------------------------|------------------|-------|
| XT02 | CLS – Clear Lens | F – Florence | L090 | ~90 lm/ft | IP00 | CT27 | 2700K | EC – End Cap | MC – Mounting Clip | Enter run length | |
| | | | L200 | ~200 lm/ft | | CT30 | 3000K | | | | |
| | | | L360 | ~360 lm/ft | | CT35 | 3500K | | | | |
| | | | L500 | ~500 lm/ft | | CT40 | 4000K | | | | |
| | | | L780 | ~780 lm/ft | | | | | | | |
| | | | L990 | ~990 lm/ft | | | | | | | |
| | DL – Drop Lens | | RGB-3535 | RGB | IP20 | N/A | | | 90C – 90° Connector | | |
| | | | RGB-3838 | RGB | | IP54 | | | | | |
| | | | RGB-5050 | RGB | | IP20 | N/A | | | | |
| | CL30 – 30° Clear Lens | | RGBW | RGBW | IP00 | N/A | | | AA – Adjustable Angle | | |
| | | | | | | IP54 | | | | | |
| | | | TW1865 | TW | IP00 | 1800-6500K | | | AA90 – 90° Adjustable Angle | | |
| | | | TW2740 | TW | | IP65 | 2700-4000K | | | | |
| | | | DTW | Dim-To-Warm | IP00 | CT2130 | 2100-3000K | | SK-A1 – Suspension Kit A1 | | |
| | | | | | | IP54 | | | | | |
| | A – Athens | | L240 | ~240 lm/ft | IP00 | CT27 | 2700K | | SK-A2 – Suspension Kit A2 | | |
| | | | L460 | ~460 lm/ft | | IP66 | CT30 | | | | 3000K |
| | | | L680 | ~680 lm/ft | | | CT35 | | | | 3500K |
| | | | | | | CT40 | 4000K | | SK-B – Suspension Kit | | |
| | | | | | | | | | | | |
| | M – Madrid | | L300 | ~300 lm/ft | IP65 | CT27 | 2700K | | | | |
| | | | L500 | ~500 lm/ft | | CT30 | 3000K | | | | |
| | | | | | | CT35 | 3500K | | | | |
| | | | | | | CT40 | 4000K | | | | |
| RGBW | | | RGBW | IP65 | | N/A | | | | | |
| CH – Coblenche H | | L195 | ~195 lm/ft | IP20 | CT27 | 2700K | | | | | |
| | | L220 | ~220 lm/ft | | IP67 | CT30 | | | | 3000K | |
| | | L235 | ~235 lm/ft | | | IP67 | | | | CT35 | 3500K |
| | | | | | CT40 | 4000K | | | | | |
| | | | | | | | | | | | |
| CS – Coblenche S | | L280 | ~280 lm/ft | IP20 | CT27 | 2700K | | | | | |
| | | L335 | ~335 lm/ft | | IP67 | CT30 | | | | 3000K | |
| | | L465 | ~465 lm/ft | | | IP67 | | | | CT35 | 3500K |
| | | | | | CT40 | 4000K | | | | | |
| | | RGBW | RGBW | | IP67 | N/A | | | | | |

Note: Lens is not required for XT02 + Coblenche IP67-RGBW

Power Supply Ordering Codes

| DTR | | + | 60 | | + | IP67 | | DTR60IP67 - Dimming, 60 Watt, IP67 | | | | | | | | |
|---|------------|------------|---|---|---|-------------|---------|------------------------------------|---|--------------------|---------|---------|-----|--------------------|--|--|
| MODEL | | + | POWER | | + | IP RATING | | INPUT | OUTPUT | DIMENSION | | | | | | |
| NTR Non-Dimming [UL Recognized] | | | 50 | 50 Watt |  | IP00 | Indoor | 88-264V | 24V | 3.90 x 3.82 x 1.42 | | | | | | |
| | | 75 | 75 Watt | 5.08 x 3.82 x 1.50 | | | | | | | | | | | | |
| | | 100 | 100 Watt | 6.26 x 3.82 x 1.50 | | | | | | | | | | | | |
| | | 150 | 150 Watt | 7.84 x 3.85 x 1.50 | | | | | | | | | | | | |
| | | 200 | 200 Watt | 8.46 x 4.53 x 1.18 | | | | | | | | | | | | |
| | | 320 | 320 Watt | 8.46 x 4.53 x 1.18 | | | | | | | | | | | | |
| | | 750 | 750 Watt | 9.84 x 5.00 x 1.61 | | | | | | | | | | | | |
| | | 960 | 960 Watt | 11.60 x 5.00 x 1.61 | | | | | | | | | | | | |
| | | 12 | 12 Watt |  | | | | | | IP42 | Indoor | 90-264V | 24V | 3.03 x 1.57 x 1.14 | | |
| | | 16 | 16 Watt | | | | | | | | | | | 3.03 x 1.57 x 1.14 | | |
| | 25 | 25 Watt | 3.31 x 2.24 x 1.16 | | | | | | | | | | | | | |
| | 35 | 35 Watt | 3.31 x 2.24 x 1.16 | | | | | | | | | | | | | |
| | 20 | 20 Watt |  | IP67 | Outdoor | 90-264V | 24V | 4.65 x 1.38 x 1.02 | | | | | | | | |
| | 35 | 35 Watt | | | | | | 5.83 x 1.57 x 1.18 | | | | | | | | |
| | 60 | 60 Watt | | | | | | 6.40 x 1.67 x 1.26 | | | | | | | | |
| | 100 | 100 Watt | | | | | | 7.48 x 2.05 x 1.46 | | | | | | | | |
| | 150 | 150 Watt | | | | | | 7.52 x 2.48 x 1.48 | | | | | | | | |
| | 240 | 240 Watt | | | | | | 9.61 x 2.68 x 1.53 | | | | | | | | |
| | 320 | 320 Watt | | | | | | 9.92 x 3.54 x 1.72 | | | | | | | | |
| DTR Dimming min 10% (0-10V) [UL Recognized] | | 16 | 16 Watt |  | IP30 | Indoor | 90-305V | 24V | 5.83 x 1.57 x 1.26 | | | | | | | |
| | | 25 | 25 Watt | | | | | |  | IP67 | Outdoor | 90-305V | 24V | 5.83 x 1.57 x 1.26 | | |
| | | 40 | 40 Watt | | | | | | | | | | | 6.40 x 1.70 x 1.26 | | |
| | | 60 | 60 Watt | | | | | | | | | | | 6.40 x 1.70 x 1.26 | | |
| | | 90 | 90 Watt | | | | | | | | | | | 6.34 x 2.40 x 1.42 | | |
| | | 96 | 96 Watt | | | | | | | | | | | 8.66 x 2.68 x 1.53 | | |
| | | 120 | 120 Watt | | | | | | | | | | | 8.66 x 2.68 x 1.53 | | |
| | | 150 | 150 Watt | | | | | | | | | | | 8.97 x 2.68 x 1.58 | | |
| | | 185 | 185 Watt | | | | | | | | | | | 8.97 x 2.68 x 1.58 | | |
| | | 240 | 240 Watt | | | | | | | | | | | 9.88 x 2.68 x 1.58 | | |
| | 320 | 320 Watt | 9.92 x 3.54 x 1.72 | | | | | | | | | | | | | |
| | 480 | 480 Watt | 10.32 x 4.92 x 1.72 | | | | | | | | | | | | | |
| | 600 | 600 Watt | 11.02 X 5.67 X 1.91 | | | | | | | | | | | | | |
| FPD Dimming min 1% (Forward Phase) [UL Recognized] | | 20 | 20 Watt |  | IP67 | Outdoor | 120V | 24V | 4.92 x 2.20 x 0.79 | | | | | | | |
| | | 40 | 40 Watt | | | | | | 4.92 x 2.20 x 0.79 | | | | | | | |
| | | 60 | 60 Watt | | | | | | 4.92 x 2.20 x 0.79 | | | | | | | |
| | | 75 | 75 Watt | | | | | | 4.92 x 2.20 x 0.79 | | | | | | | |
| | | 96 | 96 Watt | | | | | | 4.92 x 2.20 x 0.79 | | | | | | | |
| FPD Dimming min 1% (Forward Phase) with junction box [ETL Listed] | | 20 | 20 Watt |  | IP14 | Outdoor | 120V | 24V | 5.60 x 2.00 x 2.14 | | | | | | | |
| | | 40 | 40 Watt | | | | | | 5.60 x 2.00 x 2.14 | | | | | | | |
| | | 60 | 60 Watt | | | | | | 6.62 x 2.58 x 2.33 | | | | | | | |
| | | 96 | 96 Watt | | | | | | 6.62 x 2.58 x 2.33 | | | | | | | |
| | | 150 | 150 Watt | | | | | | 9.80 x 3.00 x 2.74 | | | | | | | |
| | | 200 | 200 Watt | | | | | | 9.80 x 3.00 x 2.74 | | | | | | | |
| | 300 | 300 Watt | 10.07 x 4.20 x 3.50 | | | | | | | | | | | | | |

Suspension Kit

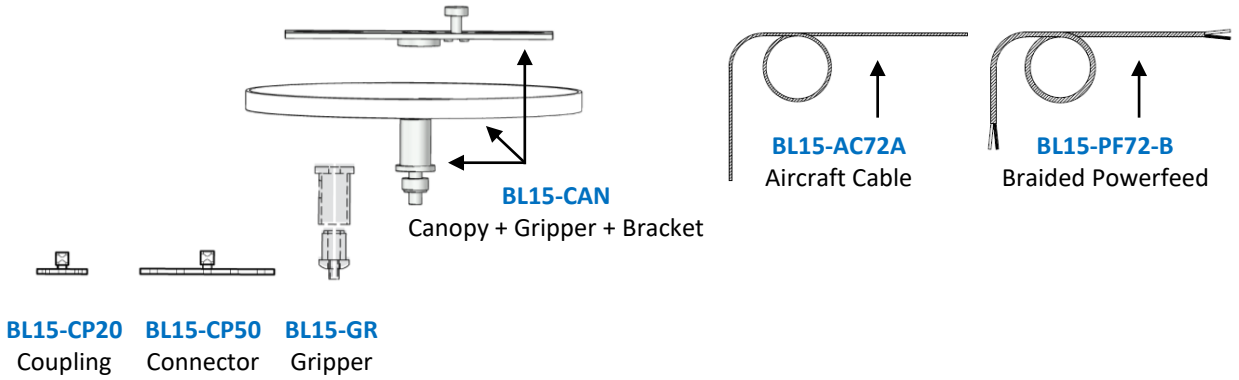

XT02-SK-A1
Suspension Kit A1
BL15-GR + BL15-CP20 +
BL15-AC72A

XT02-SK-A2
Suspension Kit A2
BL15-GR + BL15-CP50 +
BL15-AC72A

XT02-SK-B
Suspension Kit B
BL15-CP-PF + BL15-PF72-B +
BL15-CAN

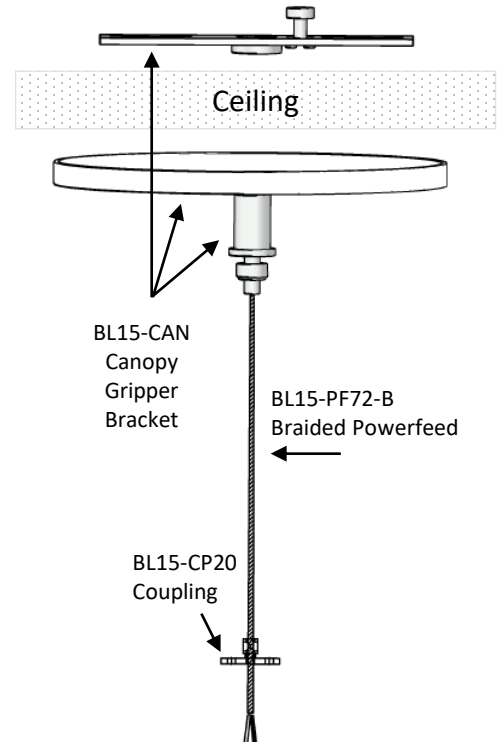
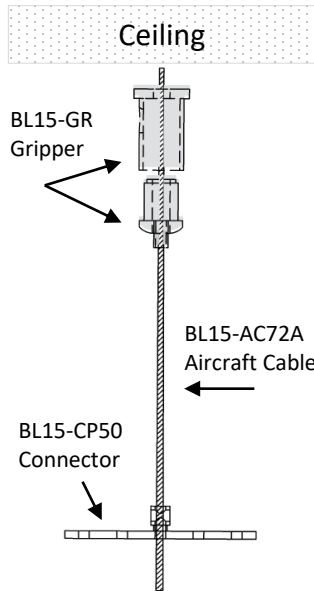
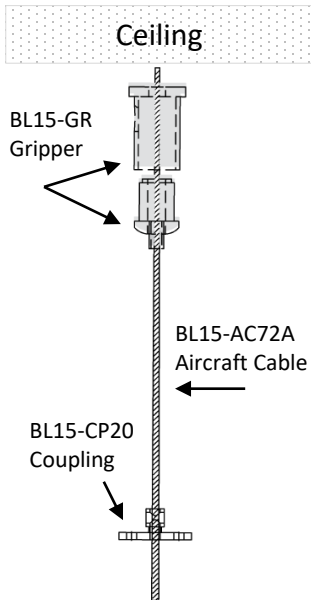

| CUSTOMIZATION | TL48 | DC99 | LN99 | EX99 | M99 | C99 | F48 | F48C | IP68 |
|--|------|------|------|------|-----|-----|-----|------|------|
| Cutting tapelight to specified length + solder 4ft leadwire | ✓ | | | | | | ✓ | ✓ | |
| Daisy Chain: Cut tapelight to specified length + 2", 6", or 12" jumper cable daisy chain between 2 run lengths | | ✓ | | | | | | | |
| Installing tapelight onto extrusion | | | | | | | ✓ | ✓ | |
| Cutting diffuser to specified length | | | ✓ | | | | ✓ | ✓ | |
| Cutting extrusion to specified length | | | | ✓ | | | ✓ | ✓ | |
| Miter corner extrusion and diffuser | | | | | ✓ | | | | |
| Filling extrusion with polyurethane (2 ft submersible) | | | | | | | | | ✓ |
| Customize extrusion to specified color | | | | | | ✓ | | ✓ | |
| Final function and quality inspection | ✓ | ✓ | ✓ | ✓ | ✓ | ✓ | ✓ | ✓ | ✓ |