

# RF RGBW Remote Controller Beulux Code: C94-6ZR

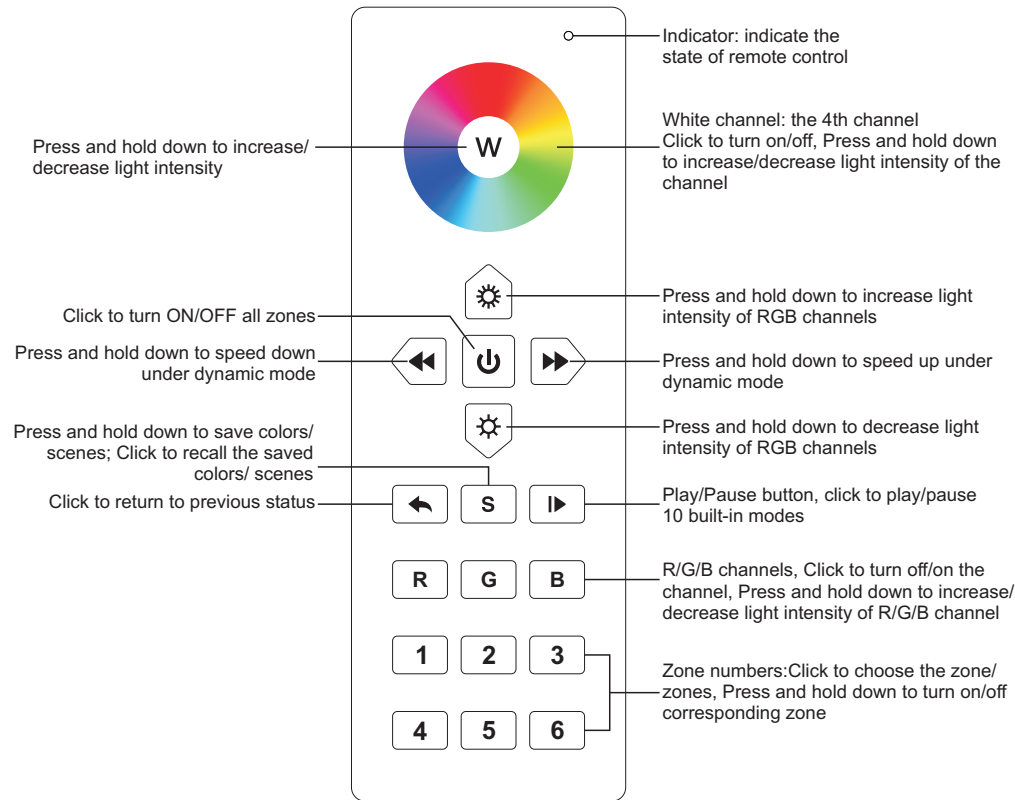

**Important:** Read All Instructions Prior to Installation

## Function introduction



Front side

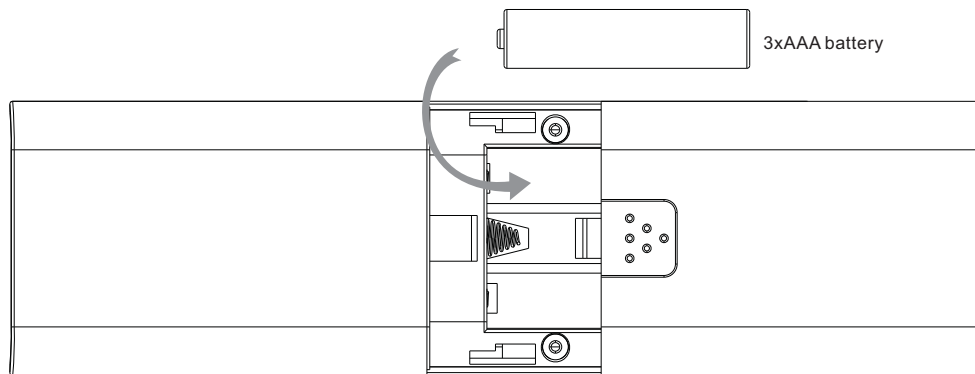

Bottom side

## Product Data

Output	RF signal
Operation Frequency	869.5/916.5/434MHz
Power Supply	4.5V(3xAAA battery)
Operating temperature	0-40°C
Relative humidity	8% to 80%
Dimensions	140x48x17mm

- Control 6 zones of RF receivers separately.
- RGBW color controller
- High sensitive & high stable fast & precise color control.
- Compatible with all universal series RF receivers
- 1 receiver can be paired by max 8 different remote controls.
- Waterproof grade: IP20

## Safety & Warnings

- This device contains AAA batteries that shall be stored and disposed properly.
- DO NOT expose the device to moisture.

## Pair with RF receiver(Method 1)

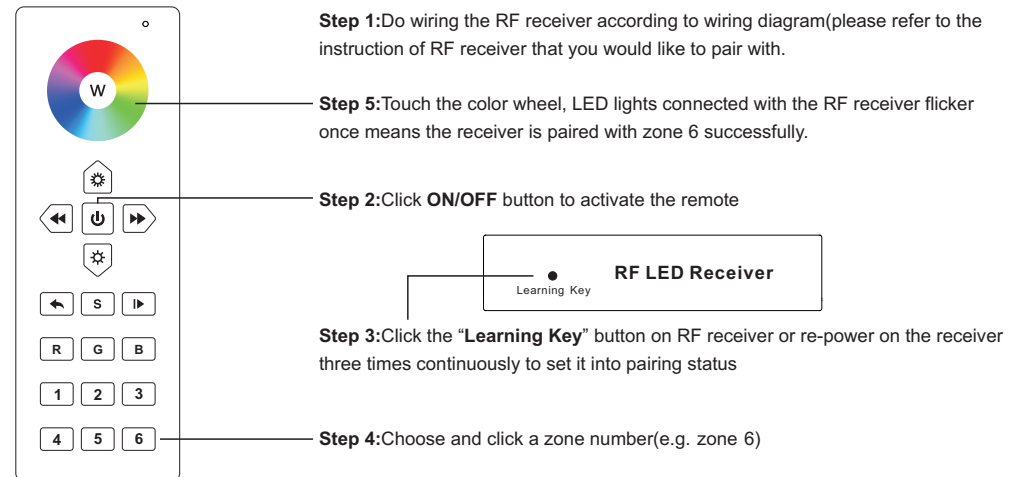

## Pair with RF receiver(Method 2)

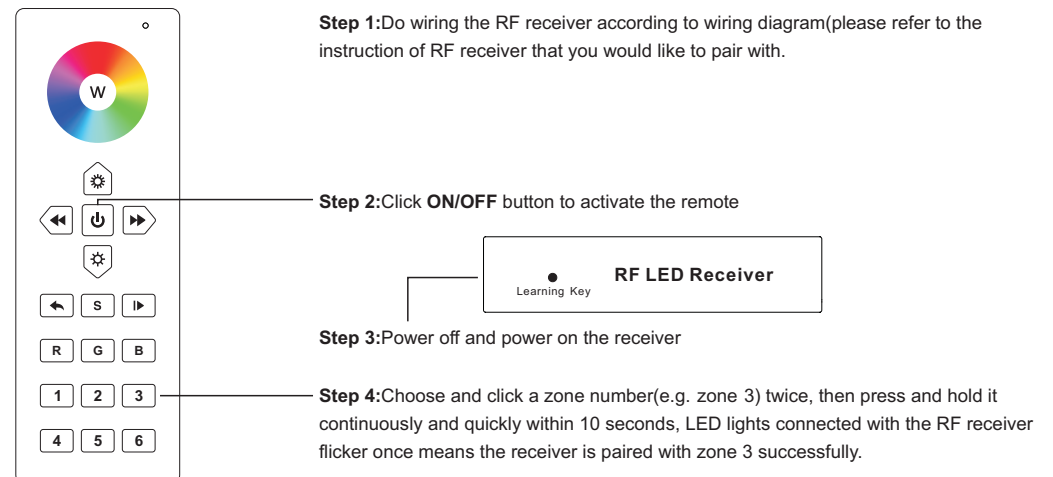

### Save color/scene/mode

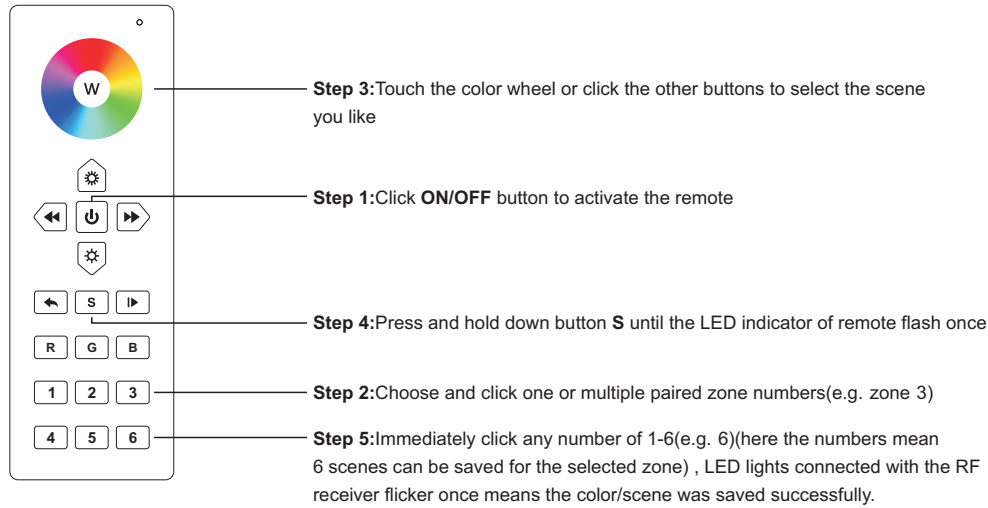

### Recall the saved colors/scenes

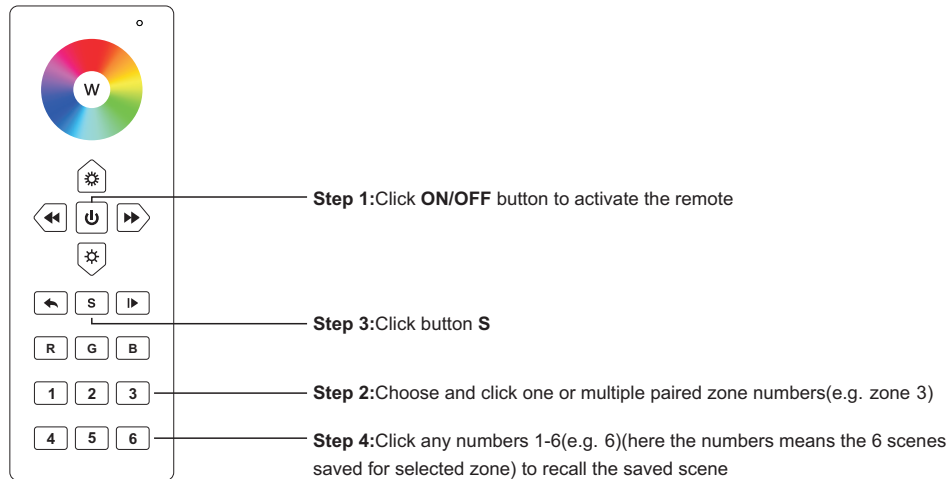

### Built-in 10 color changing modes are as follows:

- Mode 1: Any two colors of RGB mix fade-in & fade-out
- Mode 2: RGB three colors mix fade-in & fade-out
- Mode 3: RGB three colors mix fade-out & fade-in
- Mode 4: RGB flash
- Mode 5: RGB three colors fade-in & fade-out successively
- Mode 6: RGB three colors fade-in successively
- Mode 7: RGB three colors fade-out successively
- Mode 8: RGB three colors jump changing successively
- Mode 9: R&B two colors mix fade (R in B out), then G fade-in, then R&B mix fade (R out B in), then G fade-out
- Mode 10: B fade-out, then G&B mix fade (G out B in), then R&G mix fade (R out G in), then R fade-in

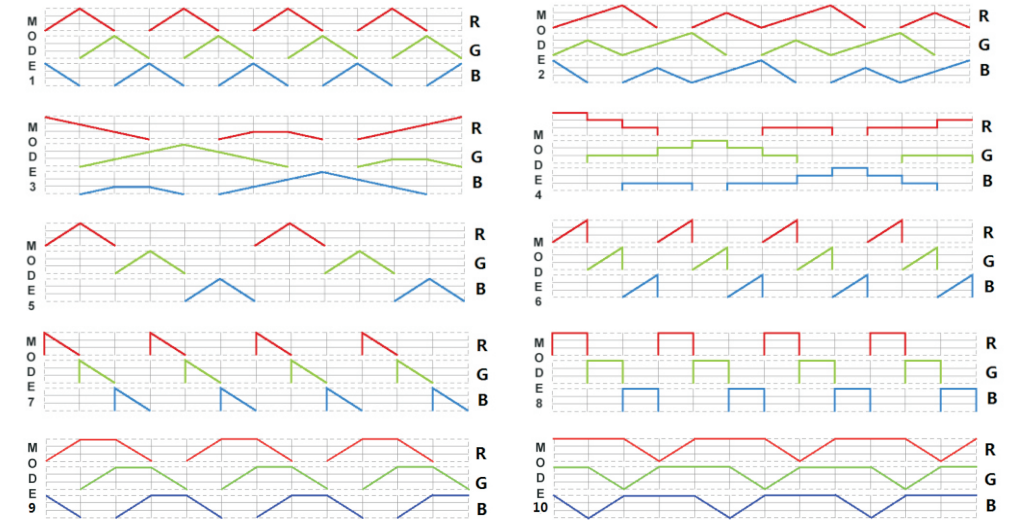

### How to stop running mode of single color LED light caused by RGBW sender interference:

1. When pairing single color LED light to a single color remote, it might be interfered and paired by nearby RGBW senders, which might control the single color light into running mode. The running mode can not be stopped by the paired single color remote or by delete pairing.
2. Then we need this remote, and pair the remote to the receiver via above "Pair with RF receiver(Method 2)", then touch the color wheel to stop the running mode.
3. Then delete pairing and pair the receiver to the single color remote again, it can be controlled by the remote again.

### If you use multiple receivers, you have two choices:

Option 1: have all the receivers in the same zone, like zone 1

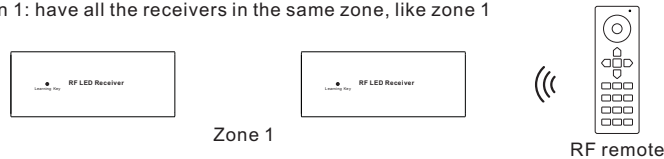

Option 2: have each receiver in a different zone, like zone 1, 2, 3 or 4

